

Solar Energy

Climate Change Forum

December 1st, 2017

10:30 am to 11:30 am

Petroleum Hall, Green Center

Colorado School of Mines

Andy Walker Phd PE

Principal Engineer NREL

The Spectral Nature of Solar Radiation

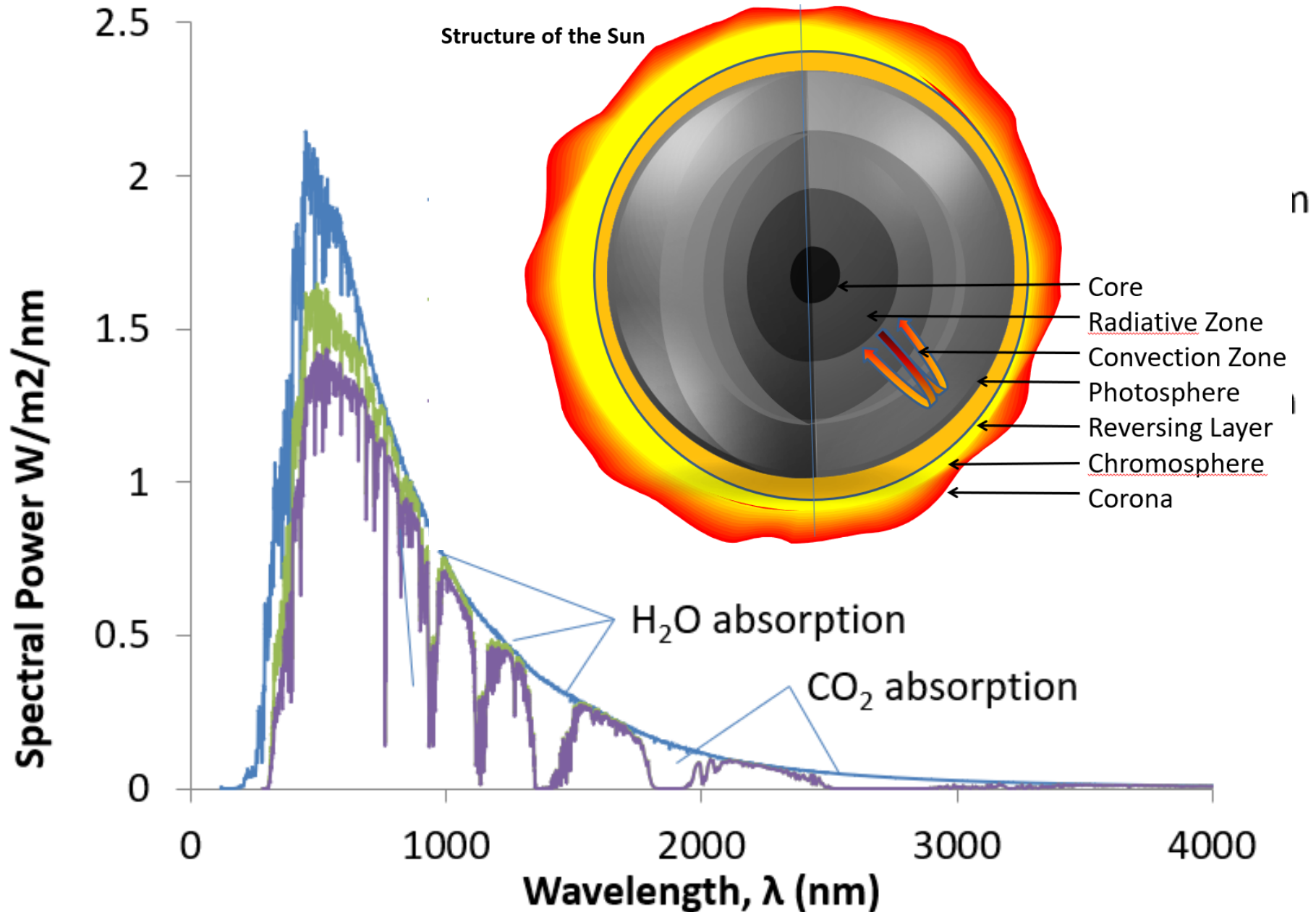

Spherical Geometry: Latitude; Time of Day; Day of Year

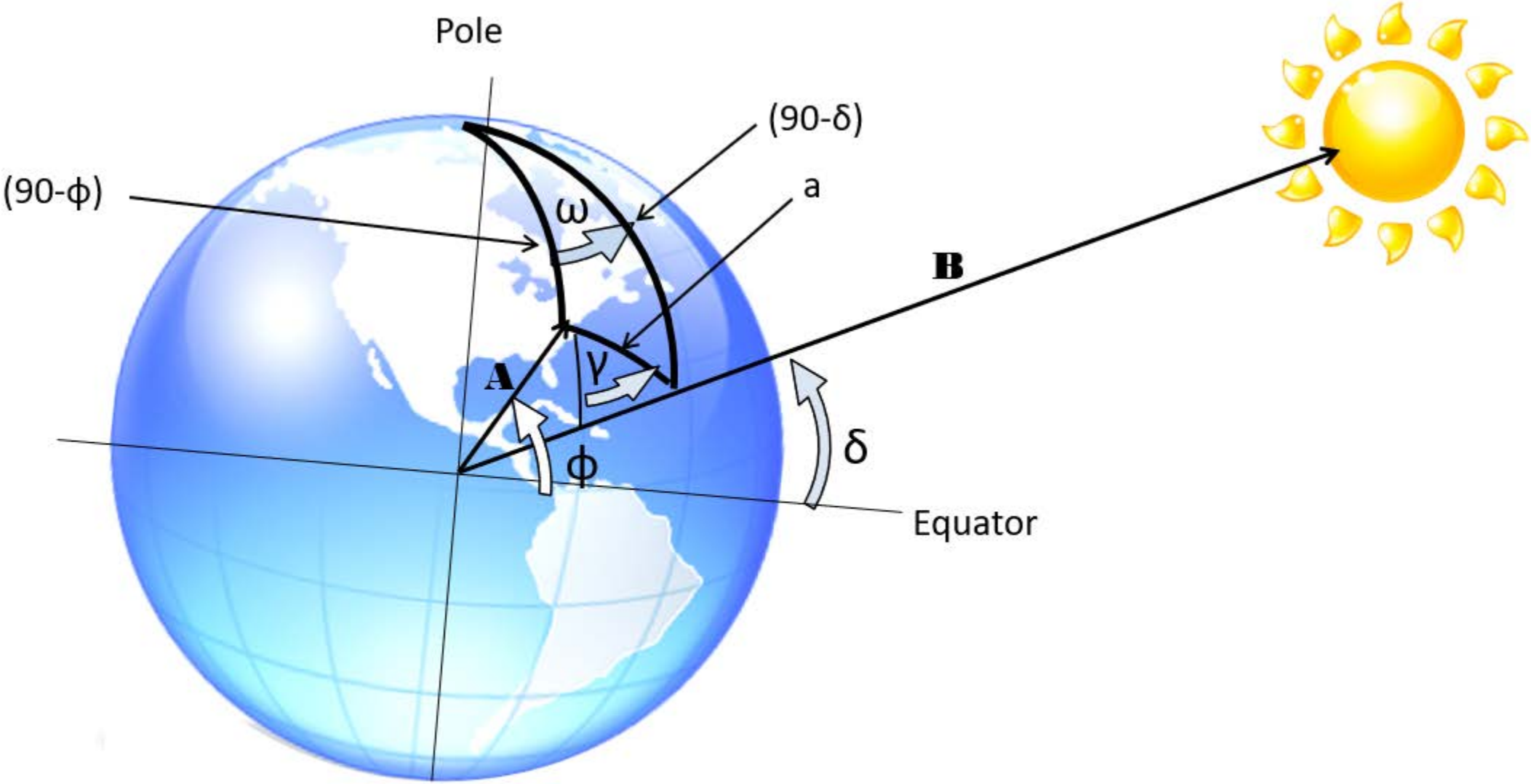

Solar Resource Maps and Data

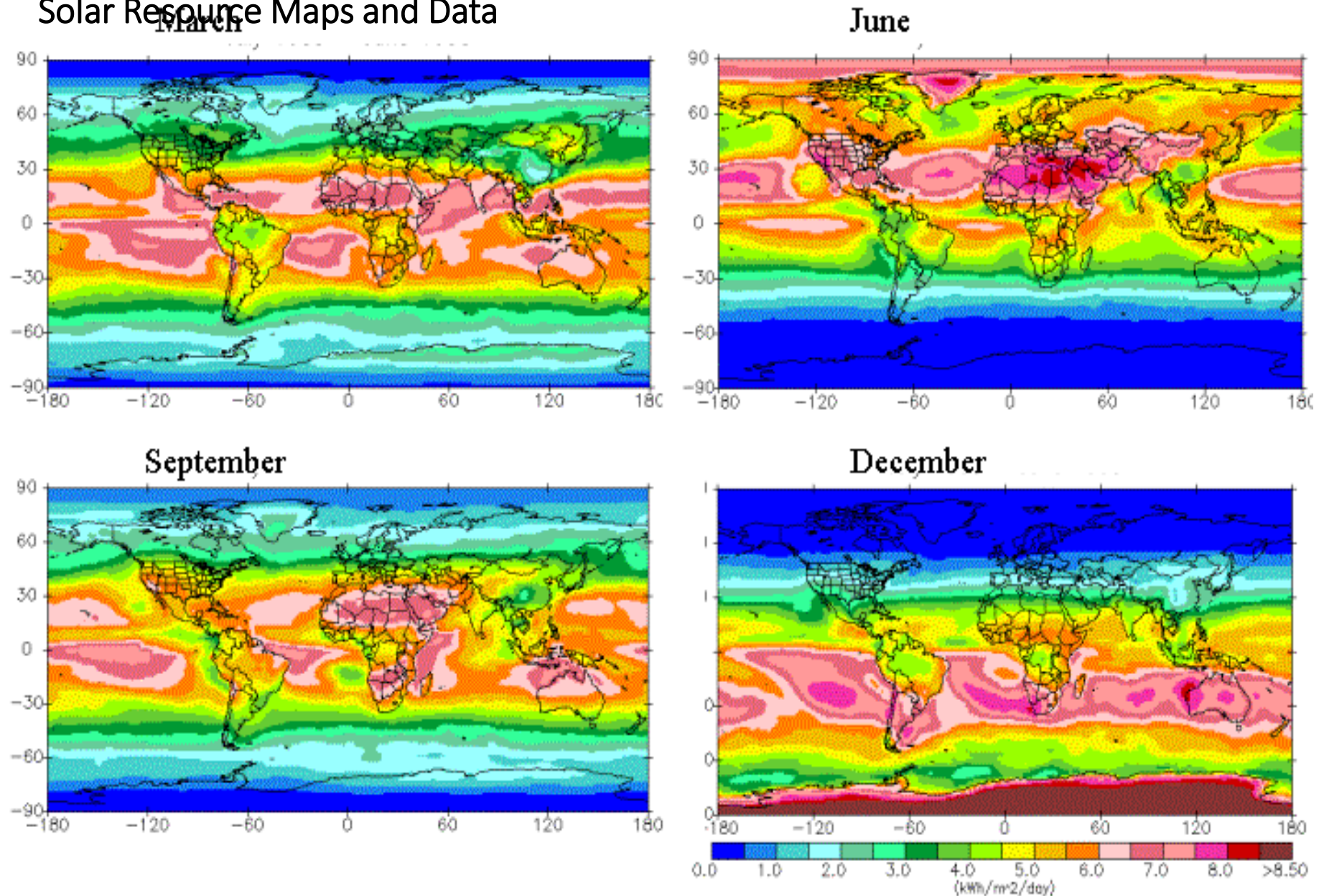

Figure 2-18. Examples of monthly solar resource maps by the NASA Surface Meteorological and Solar Energy site. (from eosweb.larc.nasa.gov/sse/)

Alternating Current (AC) PV System with Inverter

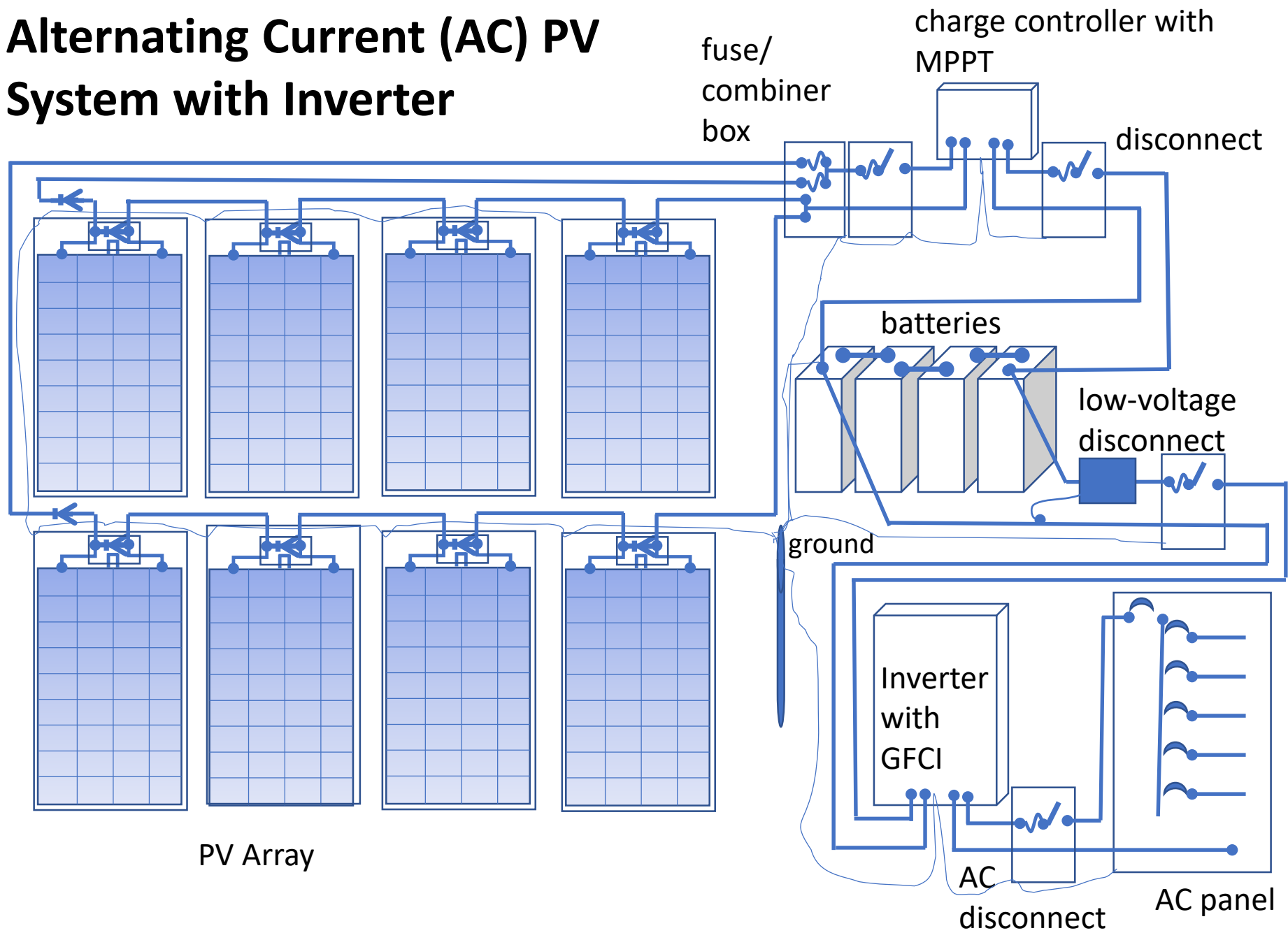
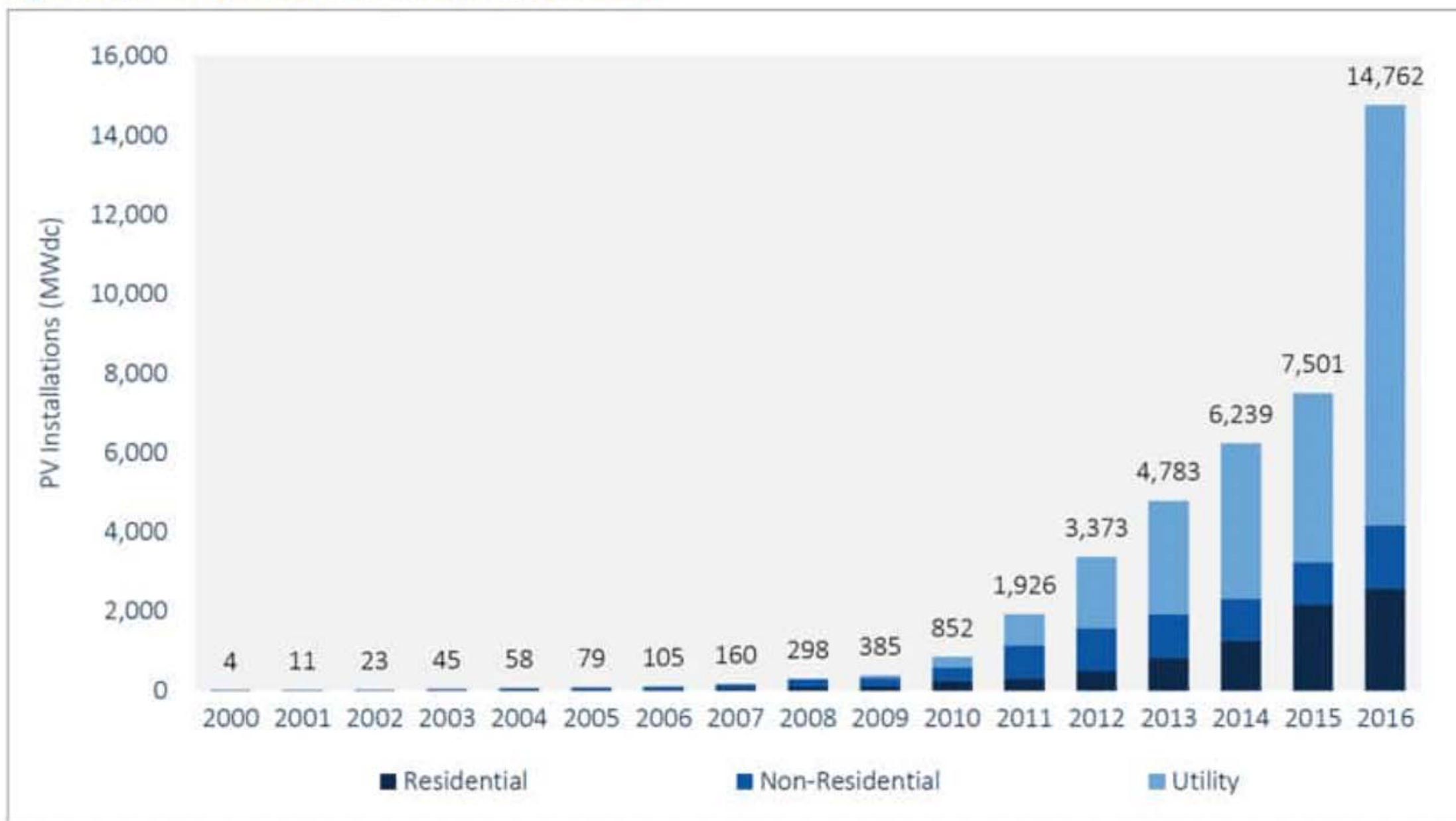
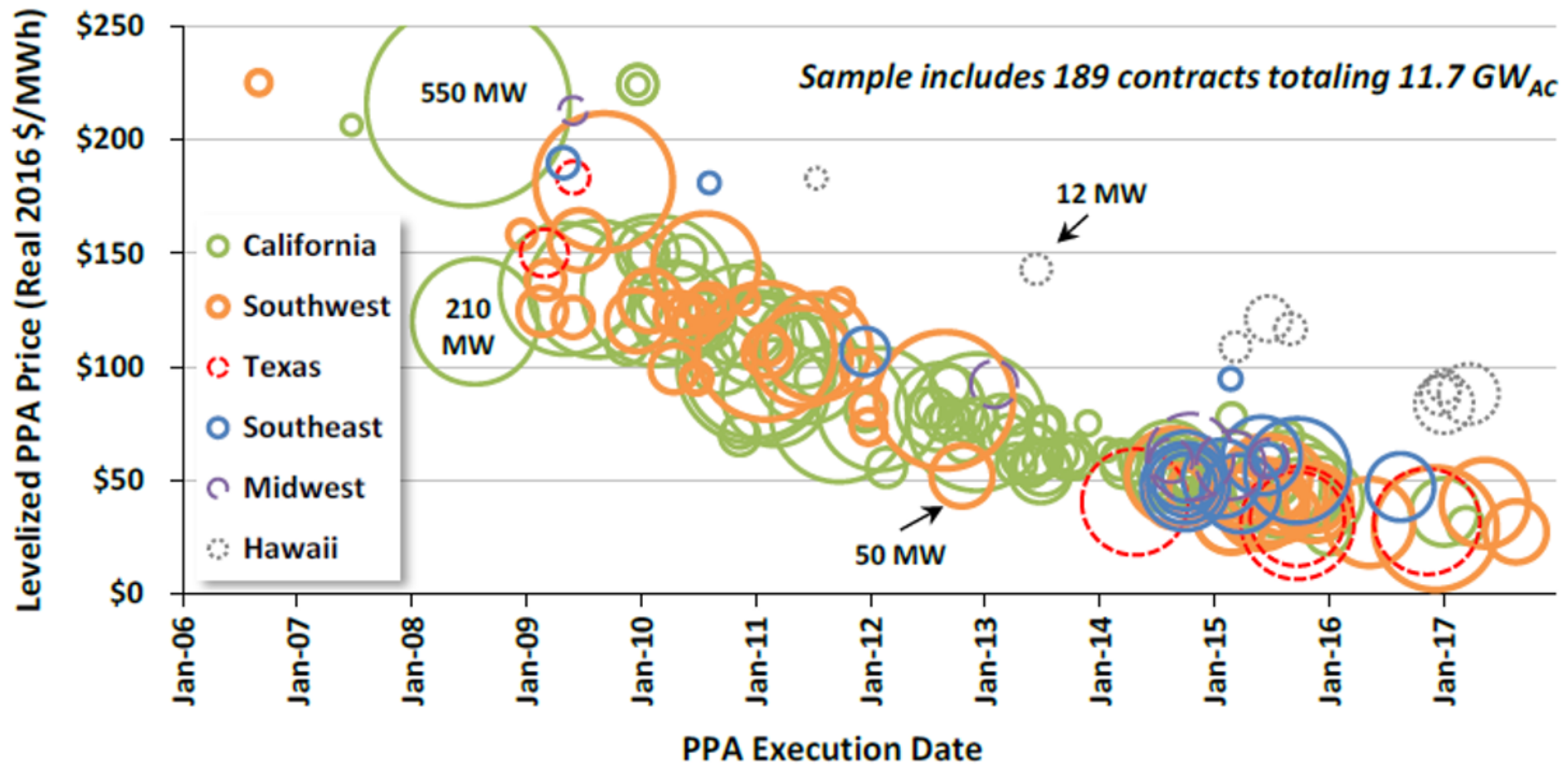

Figure 1.1 Annual U.S. Solar PV Installations, 2000-2016



Cost of Solar Energy Delivered to Customers (\$/MWh)



- There has been a strong, steady downward PPA price trend since 2006, with an average levelized price signed in 2016 of ~\$35/MWh.
 - The median unsubsidized LCOE of utility-scale PV projects built in 2016 was below the DOE SunShot target of 6 cents/kWh.

Scheduled electric generating capacity additions in 2016

gigawatts

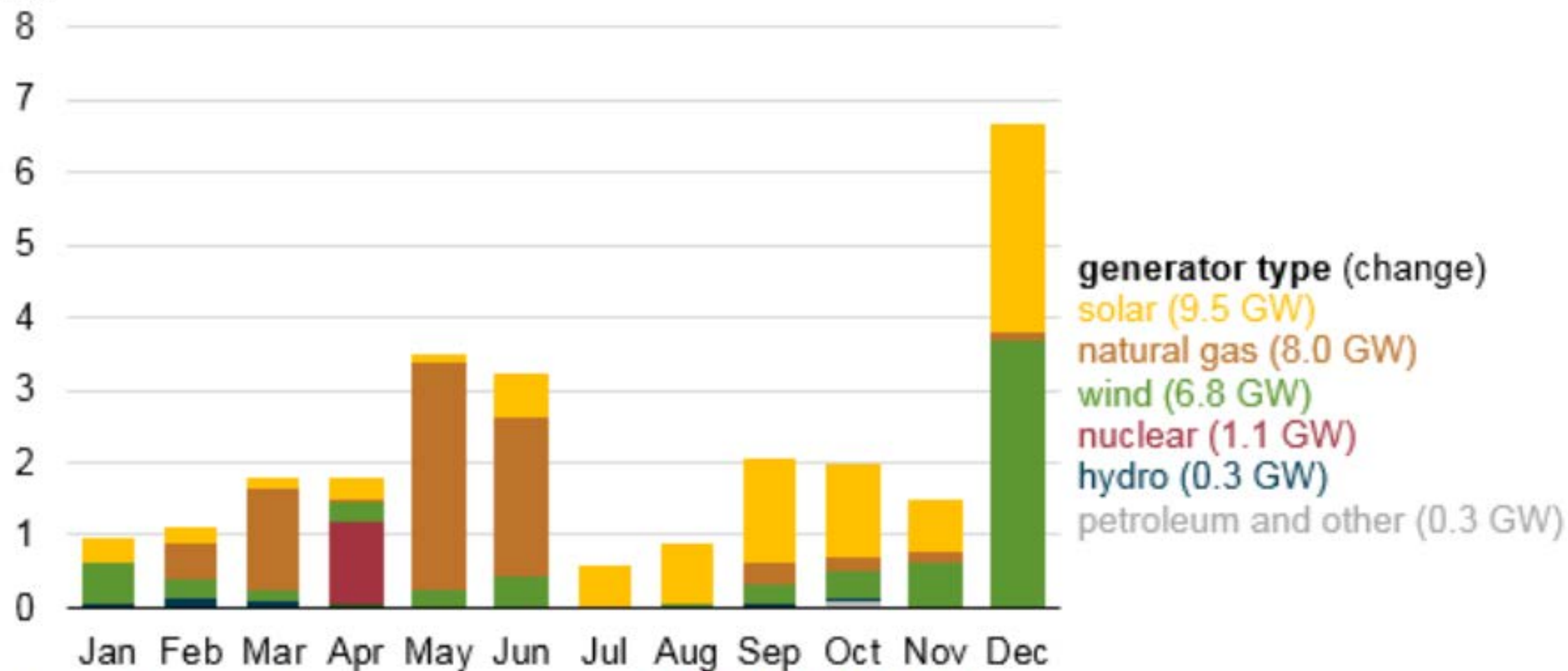

Source: U.S. Energy Information Administration, [Electric Power Monthly](#)